

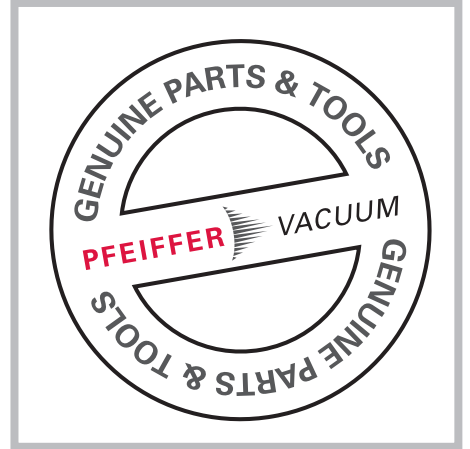

Molecular Sieve Trap, FTMS1V-40410





FTMS1V-40410

- Molecular Sieve Trap
- Traps particles and condensable vapors
- Reduces hydrocarbon backstreaming from oil-sealed pumps

Technical Data	FTMS1V-40410
Trap Type	Molecular Sieve Trap
Sieve Material	Synthetic Zeolite 13X
Port Orientation	In-Line
Flange Size/Type	KF40
Nominal Body OD	4" (100mm)
Body Material	304 Stainless Steel
Seal Material	FKM
Claw Clamps	Aluminum
Voltage and Wattage	120VAC, 42W
Vacuum Range	$> 1 \times 10^{-8}$ mbar to 1 bar
Temperature Range	-20°C to 150°C
Weight	5 lbs

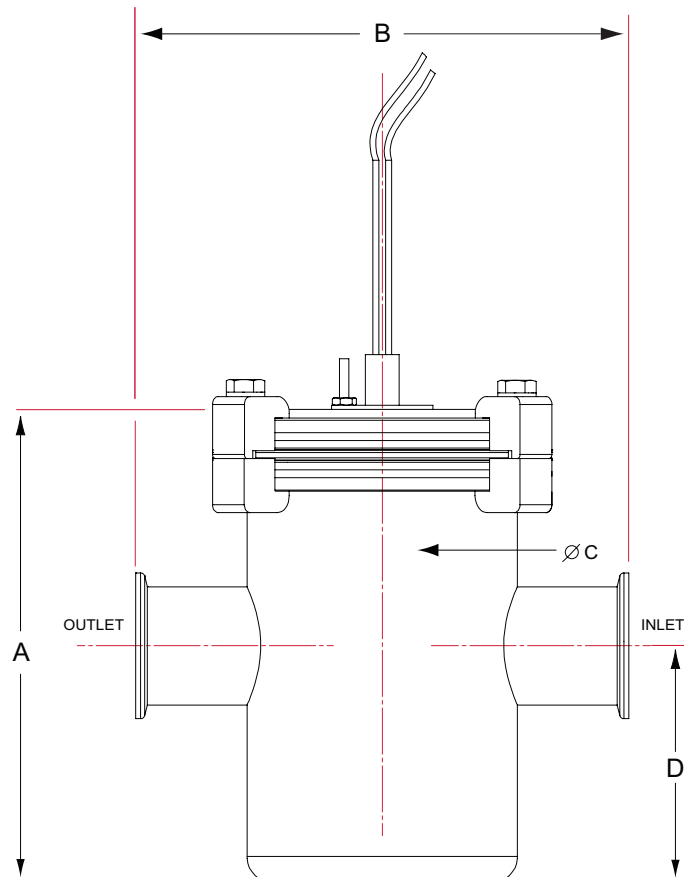

	inches (mm)
Dimension A	7 (178)
Dimension B	7.3 (185)
Dimension C	4 (100)
Dimension D	3.5 (89)

Your Success. Our Passion.

We give our best for you every day –
worldwide!



Pfeiffer Vacuum Valves & Engineering
1967 S Oregon St, Yreka, CA - USA
pvvesales.us@pfeiffer-vacuum.com
+1 800 824 4166

Follow us on social media
#pfeiffervacuum



www.n-c.pfeiffer-vacuum.com

PFEIFFER  **VACUUM**