



Similar Image



# CF 90 mitered elbow

## 6.75" OD CF mitered 90-degree elbow

Part number: 2E-500M

**CF 90 mitered elbow**  
**6.75" OD CF mitered 90-degree elbow**

- The CF flange system is ideal for UHV system construction
- Rotatable flanges make component alignment easy
- Most popular sizes and types listed
- Contact us at 800-824-4166 if you can't find exactly what you need



Similar Image

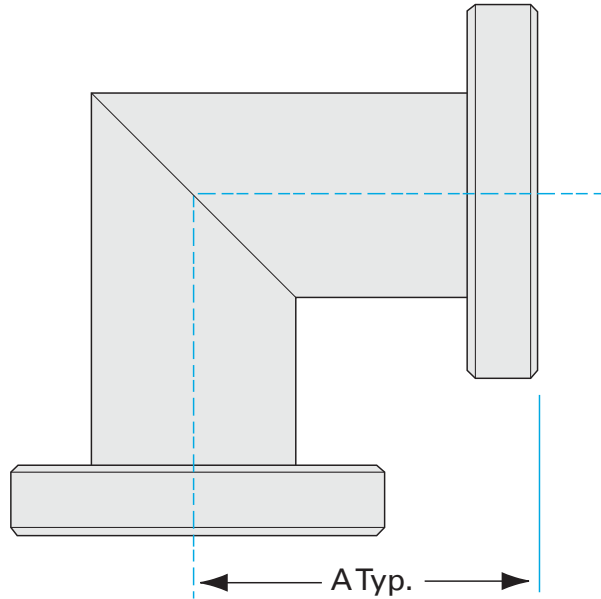

Both Flanges Rotatable

Dimensions <i>(in inches)</i>	
Dim A	4.71"

**2E-500M**

Parameters	Specifications
Flange Size	DN 125 CF (6.75" OD)
Elbow Type	Miter 90 Degree
Material	304 stainless
Tube OD	5"
Port Length	4.71"
Vacuum Range	FKM: 1 · 10 <sup>8</sup> mbar to 1 bar Metal seal: 1 · 10 <sup>13</sup> mbar to 1 bar
Temperature Range	FKM: -20 °C to 180 °C Metal seal: -200 °C to 450 °C
Weight	10.6 lbs

## VACUUM SOLUTIONS FOR INDUSTRY & RESEARCH

Nor-Cal Products is a premier global source for custom and standard high and ultra-high vacuum chambers and components critical to the success of industrial, semiconductor, coating, analytics, and research applications. We offer an extensive selection of vacuum line fittings, hardware, valves and components which complement our custom manufacturing capabilities.

## EARNING YOUR TRUST

Innovative engineering, precision manufacturing, exceptional service and expert technical support are cornerstones of our corporate culture and continuous improvement goals. Your trust is our most important asset.

## INNOVATION SINCE 1962

An added value to working with Nor-Cal Products is how we apply our vacuum science and industry expertise to your production and research goals and timelines. We continue to develop new component lines and services to serve the demands of the exciting and ever emerging applications that require vacuum components.

**Nor-Cal Products**  
Headquarters: USA  
1-800-824-4166 or 530-842-4457  
ncsales@n-c.com  
[www.n-c.com](http://www.n-c.com)



RoHS2/REACH compliant  
Conflict mineral regulations enforced

All data subject to change without prior notice.

